

LED Slim Panel Performer

Panel Model Name	Luminaire Model Name	CCT	kg	
LED PL-RC-S5 SQ595 U19-PL	LED PL-RC-S5 SQ595-30W U19	LED PL-RC-S5 SQ595-34W U19	3000K/4000K	3.0kg
	LED PL-RC-S5 SQ595-30W Dim-D U19	LED PL-RC-S5 SQ595-34W Dim-D U19	3000K/4000K	3.0kg
	LED PL-RC-S5 SQ595-30W Dim-B U19	LED PL-RC-S5 SQ595-34W Dim-B U19	3000K/4000K	3.0kg
	LED PL-RC-S5 SQ595-30W Dim-10V U19	LED PL-RC-S5 SQ595-34W Dim-10V U19	3000K/4000K	3.0kg
LED PL-RC-S5 SQ620 U19-PL	LED PL-RC-S5 SQ620-30W U19	LED PL-RC-S5 SQ620-34W U19	3000K/4000K/6500K	3.2kg
	LED PL-RC-S5 SQ620-30W Dim-D U19	LED PL-RC-S5 SQ620-34W Dim-D U19	3000K/4000K/6500K	3.2kg
	LED PL-RC-S5 SQ620-30W Dim-B U19	LED PL-RC-S5 SQ620-34W Dim-B U19	3000K/4000K/6500K	3.2kg
	LED PL-RC-S5 SQ620-30W Dim-10V U19	LED PL-RC-S5 SQ620-34W Dim-10V U19	3000K/4000K/6500K	3.2kg
LED PL-RC-S5 RE295 U19-PL	LED PL-RC-S5 RE295-30W U19	LED PL-RC-S5 RE295-34W U19	3000K/4000K	3.0kg
	LED PL-RC-S5 RE295-30W Dim-D U19	LED PL-RC-S5 RE295-34W Dim-D U19	3000K/4000K	3.0kg
	LED PL-RC-S5 RE295-30W Dim-B U19	LED PL-RC-S5 RE295-34W Dim-B U19	3000K/4000K	3.0kg
	LED PL-RC-S5 RE295-30W Dim-10V U19	LED PL-RC-S5 RE295-34W Dim-10V U19	3000K/4000K	3.0kg
* Accessories should be purchased separately.	542098006900*	LEDPanel-S4-Suspension-Kit		0.16kg
	140057770*	LEDPanelRc-SI-Mounting-Springs-595		0.13kg

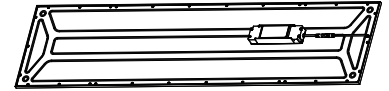
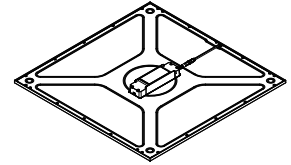

Type	A(mm)	B (mm)	C(mm)
SQ595	595	595	9
SQ620	620	620	
RE295	295	1195	

Type	L1(mm)	L2(mm)	L3(mm)
SQ595	500	500	500
SQ620			
RE295			

100 Min

Do not cover with insulation material

BLE version, Do not put in a closed metal or cement space.

TOUCH DIM FUNCTIONALITY (For DALI2 System)

Warning: TD function and DALI function can't be used at the same time, avoid damaging the DALI system by high voltage.

Function	Contact Duration	Reaction
Ignore	< 50ms	Nothing
Short Push	50-500ms	Turn on or off
Long Push	> 500ms	Dimming up or down
Synchronisation	10s	Go to SYNC level, 50%
	20s	Go to SYNC level, 100%

Touch Dim Terminal Consumption: Typical 3mA(220V).

Terminal block not included.
Installation may require advice from a qualified person.
Only use suitable connection boxes with internal terminal blocks conform to EN60998-2-1 or EN60998-2-2. Terminal should be capable for at least 450V 16A, 0.75mm² wiring.

Luminaires not suitable for covering with thermally insulating material.
Leuchten sind nicht mit thermisch isolierenden Materialien abzudecken.

In case of damage to the wire, it has to be replaced only by the manufacturer, distributor or by an expert, to avoid risks.
Caution: Any operation on LED module is forbidden while power-on.
Zur Vermeidung von Risiken müssen defekte Leitungen ausschließlich vom Hersteller, Inverkehrbringer oder Fachmann ausgetauscht werden.
Achtung: In Betrieb ist keine Arbeit am LED-Modul erlaubt.

For non-user replaceable light sources.
The light source contained in this luminaire shall only be replaced by the manufacturer or his service agent or a similar qualified person.

Suzhou Opplle Lighting Co.,Ltd.
215200
East Side, Fenyang Road,
Fenhu Economic Development Zone,
Wujiang City, Jiangsu Province,
P.R.China

Opplle Lighting BV
Meerenakkerweg 1.11
5652 AR Eindhoven
The Netherlands
service@opplle.com
www.opplle.com
250053335001

Recessed Mounting (Lay-in)

For DALI/10V

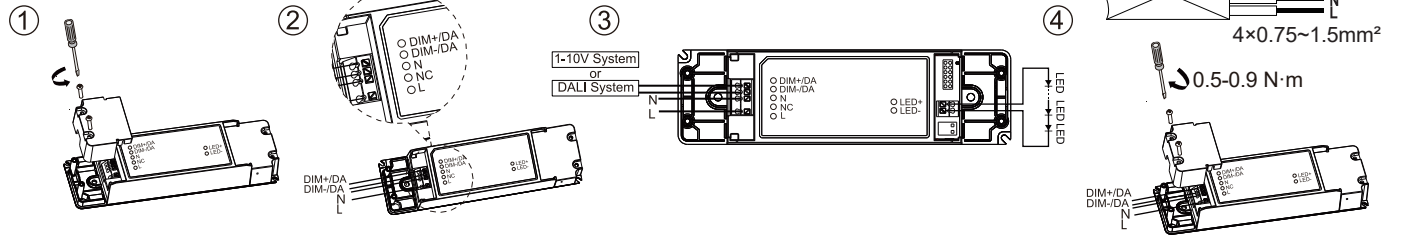

For BLE

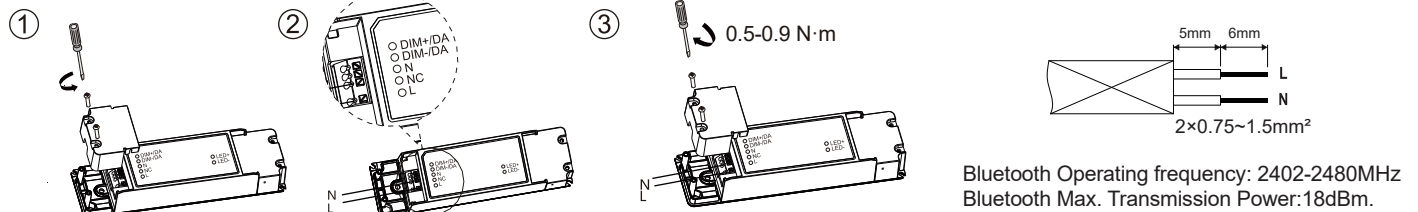

For Static

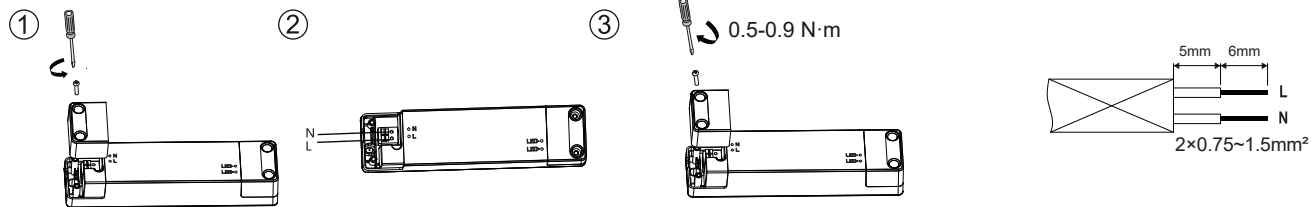

Suspension (Suspension kit to be purchased separately)

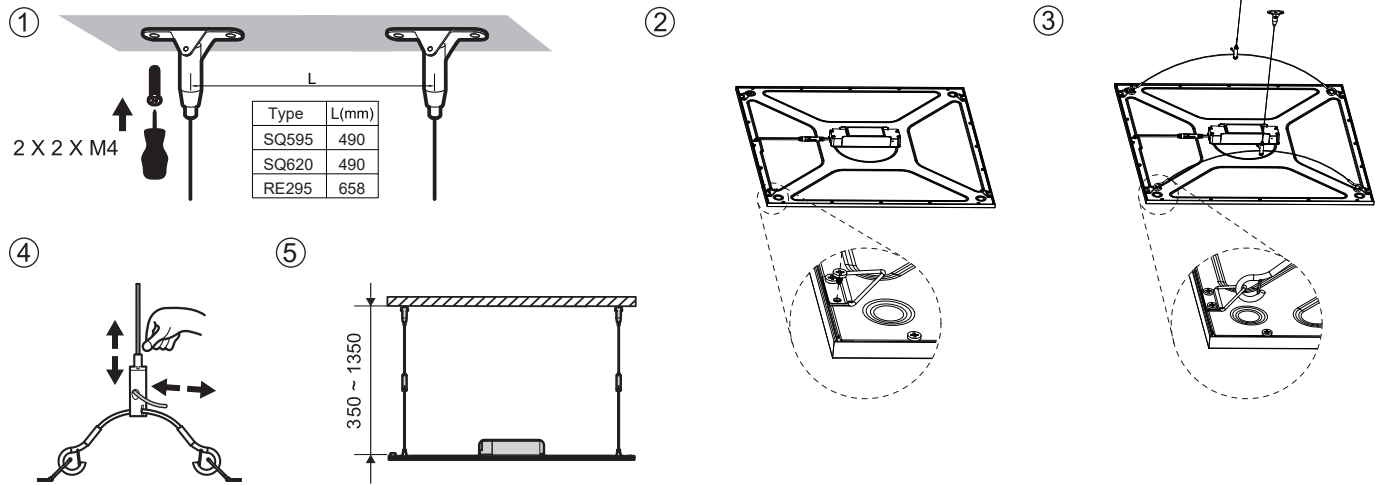

Recessed Mounting (Clips)

For Static/DALI/10V

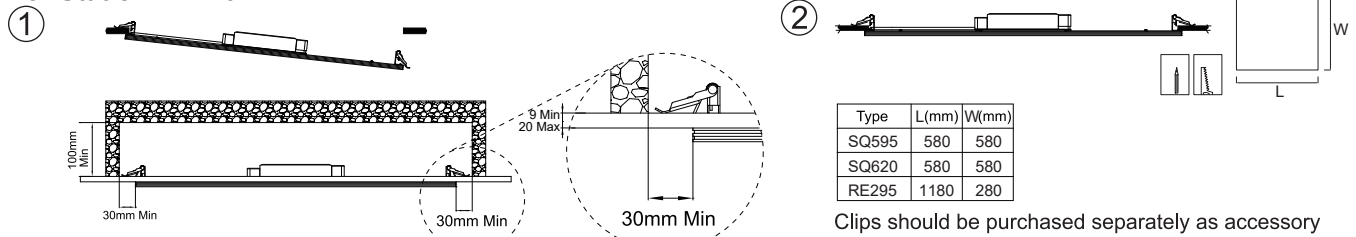

For BLE Do not put in a closed metal or cement space.

