

# Uniled IsoSafe Airtight



<p>200mA, 36V, 8,5W</p> <p>35 mm</p> <p>Ø94 mm</p>	<p>220-240V, 50/60Hz</p> <p>L x W x H 102 x 51 x 22 mm</p>
<p>Min. 28mm</p> <p>10-25 mm</p> <p>SG Multibox    SG Concretebox SG Multibox TEK    SG Unibox SG Multibox Mini</p>	
<p>10-25 mm</p>	
<p>↓ IP65</p> <p>↑ IP65*</p> <p>↓ IP65</p> <p>↑ IP65*</p>	<p>*</p> <p>NO: Pakning EN: Gasket FR: Joint d'étanchéité NL: Pakking DE: Dichtung FI: Tiiviste</p>
<p><b>NO:</b> Skru av strømmen før montering. <b>DK:</b> Sluk for strømmen inden montering. <b>SE:</b> Stäng av strömmen innan montering. <b>EN:</b> Turn off power before installing. <b>FR:</b> Couper le courant avant l'installation. <b>NL:</b> Stroom uitschakelen voor u het toestel installeert. <b>DE:</b> Vor Installationsarbeiten den Strom abschalten. <b>FI:</b> Sammuta virta ennen kytkemistä</p> <p><b>NO:</b> Kan kun installeres og vedlikeholdes av en registrert installasjonsvirksomhet. <b>DK:</b> Må kun installeres og vedligeholdes af uddannet elektriker. <b>SE:</b> Skall installeras och underhållas av behörig elektriker. <b>EN:</b> Only to be installed and maintained by an authorized electrician. <b>FR:</b> Doit être installé et maintenu par un électricien qualifié. <b>NL:</b> Mag alleen geïnstalleerd en onderhouden worden door een bevoegde electricien. <b>DE:</b> Dieses Produkt darf nur durch autorisiertes Personal (z.B. Elektro-Installateur) angeschlossen, in Betrieb genommen und gewartet werden. <b>FI:</b> Asentaa ja huoltaa saa vain valtuutettu sähköasentaja</p>	

**NORWAY**  
SG Armaturen AS

Skytterheia 25  
N-4790 Lillesand

Tel: +47 37 50 03 00  
firmapost@sg-as.no  
www.sg-as.no

**SWEDEN**  
SG Armaturen AB  
Tel: +46 31 81 71 10  
info@sg-ab.se  
www.sg-ab.se

**FINLAND**  
SG Armaturen Oy  
Tel: +358 02 07 30 39 60  
info@sg-oy.fi  
www.sg-oy.fi

**DENMARK**  
SG Armaturen A/S  
Tel: +45 70 70 72 13  
info@sg-as.dk  
www.sg-as.dk

**UNITED KINGDOM**  
SG Lighting LTD  
Tel: +47 37 50 03 00  
info@sighting.co.uk  
www.sighting.co.uk

**FRANCE**  
SG Lighting SA/NV  
Tel: +33(0) 4 94 93 00 00  
info.france@sighting.net  
www.sighting.net

**BENELUX**  
SG Lighting SA/NV  
Tel: +32(0) 15 20 72 71  
info.benelux@sighting.net  
www.sighting.net

**GERMANY**  
SG Leuchten GmbH  
Tel: +49 40 23 99 44 59  
info@sg-leuchten.de  
www.sg-leuchten.de

**INTERNATIONAL**  
SG Lighting Co Ltd.  
Tel: +86 769 88 49 20 88  
cindy@sighting.com  
www.sg-as.com

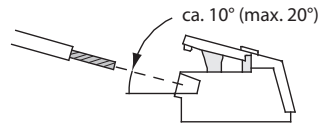
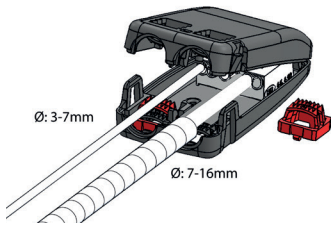

Max. 16A

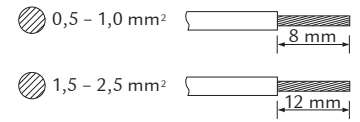

## Dipswitch

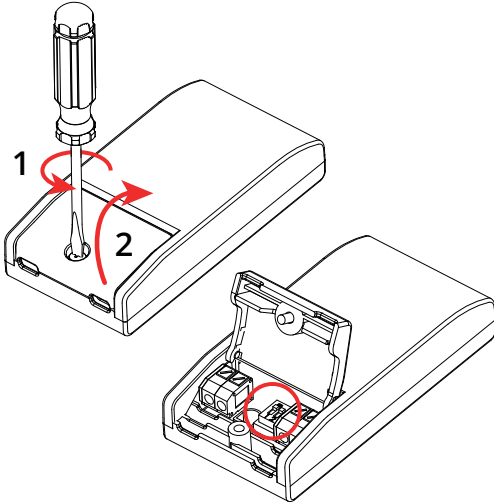

Standard

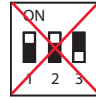
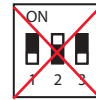
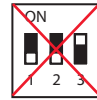
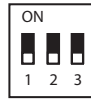

<b>mA</b>	<b>200</b>	250	300	350	400	450
<b>lm</b>	<b>100%</b>	-	-	-	-	-